

SP, 1 LIGHTED INSULATED BOWL, MECHANICAL CONTROL AND N-UV SANITIZING SYSTEM



**Ref: 562370
(SP1NUV)**

SP1 UV STD 230/50 WHITE - GAS R290

General Features

SP is a compact countertop machine that dispenses cold creams, sherbets, and other creamy specialties.

SP UV is the first and only equipment that has a n-UV LED-lighting system for sanitizing the product inside the bowl. This is a groundbreaking innovation in the industry.

n-UV LED reduce bacterial proliferation, ensuring a wholesome, high-quality dispensed product.

SP1 UV has n. 1 I-Tank insulated bowl with 5 litres capacity, an elegant design and rounded shapes, stainless steel finishes and white or black plastics.

The bowl of SP UV is illuminated by LED lights, giving the equipment an even more attractive look, enhancing the product, increasing its visibility and encouraging impulse purchases.

It works with water or milk-based powdered preparations or ready-made mixes in cartons to be poured directly into the bowl.

Easy to use and clean, all parts that come in contact with the product can be disassembled without using any tools.

SP also offers a significant ROI due to its high overrun.

The R290 natural refrigerant gas and I-Tank as standard.

Everything has been studied and designed to ensure easy and quick operations, high performances and the quality of the dispensed product: i.e. the new screw for adjusting product hardness, the hybrid consistency control, the sensor that controls the temperature in the "defrost" mode, thus avoiding sudden fluctuations that would degrade the product and compromise the final result, and the innovative n-UV sanitizing system.

SP, 1 LIGHTED INSULATED BOWL, MECHANICAL CONTROL AND N-UV SANITIZING SYSTEM

SPM

SP, 1 LIGHTED INSULATED BOWL, MECHANICAL CONTROL AND N-UV SANITIZING SYSTEM

Specifications

- Safety stop system.
- It is possible to customize the graphics on the front, on the lid and on the back (subject to negotiation).
- Thanks to the n-UV sanitizing system, this equipment is particularly suitable for dairy-based products.
- Hybrid control of consistency: to ensure the same consistency of the product, from the first to the last drop dispensed.
- Temperature control also in “defrost” mode: thus avoiding sudden fluctuations that would degrade the product and compromise the final result.
- The bowl is illuminated by LED lights, enhancing the product, increasing its visibility and encouraging impulse purchases.

Construction

- The patented I-Tank insulated bowl reduces the impact of ambient temperature on the product, improving its cooling efficiency and guaranteeing energy and cost savings.
- Exclusive n-UV LED system for bowl sanitation that reduces bacterial proliferation, ensuring a wholesome, high quality dispensed product.
- Dispenser for cold creams, sherbets, slushies, and other cold creamy specialties.
- n. 1 I-Tank insulated bowl containing 5-litres of finished product.
- New screw user-friendly for adjusting product hardness
- R290 natural refrigerant gas as standard.

SPM

www.spm.drink-systems.com
infospm@electroluxprofessional.com

SP, 1 LIGHTED INSULATED BOWL, MECHANICAL CONTROL AND N-UV SANITIZING SYSTEM

Electric

Supply voltage:	220-240 V / 1 ph / 50 Hz
Electrical power max.:	0.31 kW
Current consumption:	2.2 Amps
Plug type:	CE-SCHUKO

Key Information:

Number of bowls:	1
Bowl's capacity:	5 lt
Control board:	
Dimensions, Width:	262 mm
Dimensions, Depth:	427 mm
Dimensions, Height:	612 mm
Net weight:	28 kg
Cooling system:	AIR

Refrigeration Data

Refrigerant gas:	R290
------------------	------

Certifications



The company reserves the right to make modifications to the products without prior notice. All information correct at time of printing.

2026.04.21

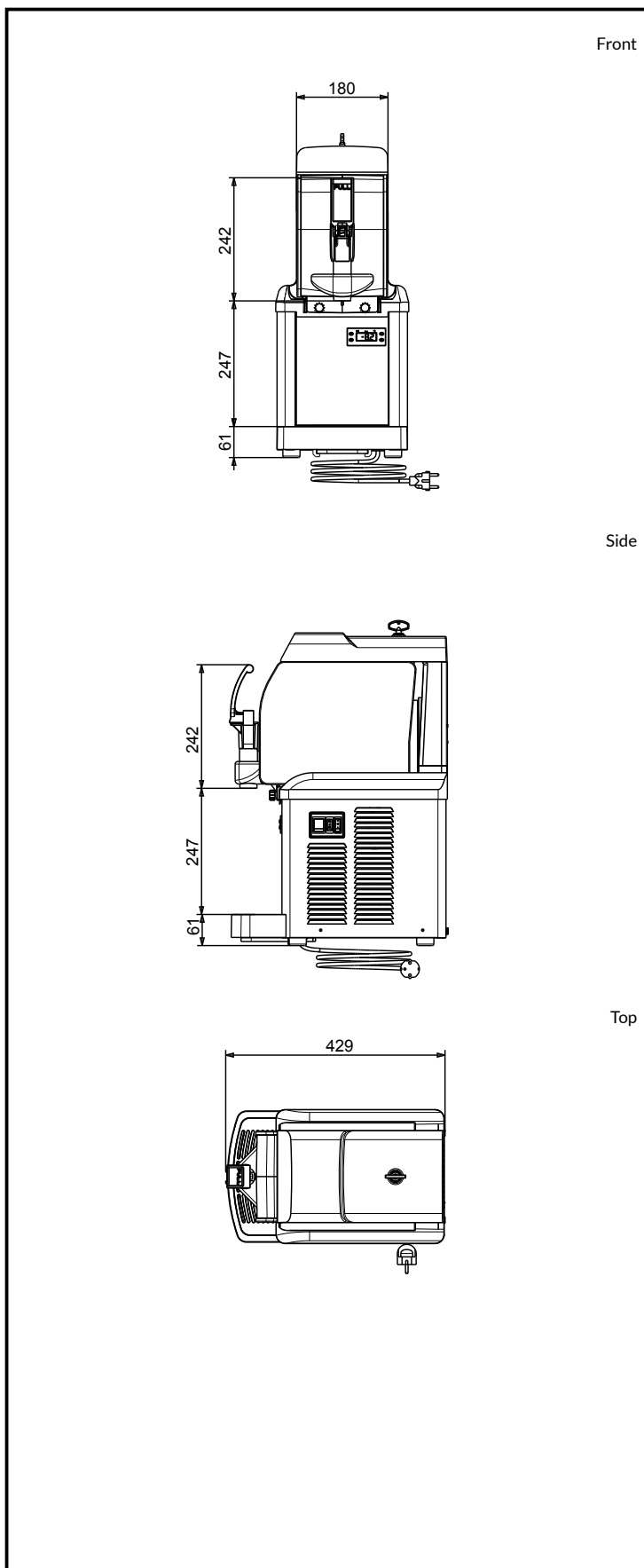

SPM

www.spm.drink-systems.com
infospm@electroluxprofessional.com